

JinkoSolar Photovoltaic Module



Installation Manual

Solar
Jinko
Building Your Trust in Solar

Contents

1	General Information	1
1.1	Overview	1
1.2	Warnings	1
<hr/>		
2.	Installation	3
2.1	Installation safety	3
2.2	Installation Condition	4
2.2.1	Climate condition	4
2.2.2	Site selection	4
2.2.3	Tilt angle selection	5
2.3	Mechanical Installation introduction	5
2.3.1	Fixation with bolts	6
2.3.2	Fixation with clamps	7
2.3.2.1	Fixation with clamps at long sides of frames	8
2.3.2.2	Fixation with clamps at short sides of frames	9
2.3.2.3	Fixation with clamps at the long & short sides	9
2.3.3	Fixation with screws & clamps at the long & short sides	10
<hr/>		
3	Wiring and connection	10
<hr/>		
4	Maintenance and care	12
4.1	Visual Inspection	12
4.2	Cleaning	12
4.3	Inspection of Connector and Cable	13
<hr/>		
5	Electrical specification	13
<hr/>		
6	Disclaimer of Liability	13
<hr/>		
	Appendix : Applicable Products	14
<hr/>		

1. General Information

1.1 Overview

Thanks for choosing Jinko Solar PV modules. In order to ensure the PV modules are installed correctly, please read the following installation instructions carefully before modules are installed and used.

Please remember that these products generate electricity and certain safety measures need to be taken to avoid danger.

Make sure the module array is designed in such a way not to exceed the maximum system voltage of any system component such as connectors or inverters.

The assembly is to be mounted over a fire resistant roof covering rated for the application. Before mounting the module, please consult your local building department to determine approved roofing materials.

The modules are qualified for application class A: Hazardous voltage (IEC 61730: higher than 50V DC; EN 61730: higher than 120V), hazardous power applications (higher than 240W) where general contact access is anticipated. Modules qualified for safety through EN IEC 61730 -1 and - 2 within this application class are considered to meet the requirements for Safety Class II.

1.2 Warnings

- PV modules generate DC electrical energy when exposed to sunlight or other light sources. Active parts of module such as terminals can result in burns, sparks, and lethal shock.
- Artificially concentrated sunlight shall not be directed on the module or panel.
- Front protective glass is utilized on the module. Broken solar module glass is an electrical safety hazard (may cause electric shock or fire). These modules cannot be repaired and should be replaced immediately.
- To reduce the risk of electrical shocks or burns, modules may be covered with an opaque material during installation to avoid injury.
- The installation work of the PV array can only be done under the protection of sun-sheltering covers or sunshades and only qualified person can install or perform maintenance work on this module.
- Follow the battery manufacture's recommendations if batteries are used with modules.



- Do not use this module to replace or partly replace roofs and walls of living buildings.
- Do not install modules where flammable gas may be present.
- Do not remove any part installed by Jinko Solar or disassemble the module.
- All instructions should be read and understood before attempting to install, wire, operate and maintain the module.
- Don't lift up PV modules using the attached cables or the junction box.
- Do not touch live terminals with bare hands. Use insulated tools for electrical connections.



- All PV systems must be grounded to earth. If there is no special regulation, please follow the National Electrical Code or other national code.
- Under normal conditions, a photovoltaic module is likely to experience conditions that produce more current and/or voltage than reported at standard test conditions. Accordingly, the value of I_{sc} and V_{oc} marked on the module should be multiplied by 1.25 when determining PV system component voltage ratings, conductor current ratings, fuse sizes, and size of controls connected to the PV output.
- Once the PV module has been shipped to the installation site, all of the parts should be unpacked properly with care.
- Do not stand or step on the PV module like below pictures show. This is prohibited and there is a risk of damage to the module and cause injury for you.



- Only PV modules with the same cell size should be connected in series.
- During transporting modules, please attempt to minimize shock or vibration to the module, as this may damage the module or lead to cell micro cracks.
- During all transportation situations, never drop the module from a vehicle, house or hands.

This will damage module.

- Do not clean the glass with chemicals. Only use tap water. Make sure the module surface temperature is cool to the touch. Cleaning modules with cool water when module surface temp is high may result in glass breakage.
- Do not disconnect any of the modules when under load.
- When looking at PV modules with anti-reflection (AR) coating technology, it will be normal to see some cells with a slight color difference at different angles.
- Connector of junction box can not be contacted with oily substances, for example, lubricant, rust inhibitor etc.

2. Installation

2.1 Installation safety

- Always wear protective head gear, insulating gloves and safety shoes (with rubber soles).
- Keep the PV module packed in the carton until installation.
- Do not touch the PV module unnecessarily during installation. The glass surface and the frame may be hot. There is a risk of burns and electric shock.
- Do not work in rain, snow or windy conditions.
- Due to the risk of electrical shock, do not perform any work if the terminals of the PV module are wet.
- Use insulated tools and do not use wet tools.
- When installing PV modules, do not drop any objects (e.g., PV modules or tools).
- Make sure flammable gasses are not generated or present near the installation site.
- Insert module connectors fully and correctly. An audible "click" sound should be heard. This sounds confirms the connectors are fully seated. Check all connections.
- The module leads should be securely fastened to the module frame, Wire Management should be done in a way to avoid the connector from scratching or impacting the back sheet of the module.
- Do not touch the junction box and the end of the interconnect cables (connectors) with bare hands during installation or under sunlight, regardless if the PV module is connected to or disconnected from the system.
- Do not expose the PV module to excessive loads on the surface of the PV module or twist the frame.
- Do not hit or put excessive load on the glass or back sheet, this may break the cells or cause micro cracks.

- During the installation or operation, don't use sharp tools to wipe the back sheet and glass. Scratches can appear on the module.
- Do not drill holes in the frame. It may cause corrosion of the frame.
- When installing modules on roof mounted structures, please try to follow the "from top to bottom" and/or "from left to right" principle, and don't step on the module. This will damage the module and would be dangerous for personal safety.

2.2 Installation Condition

2.2.1 Climate condition

Please install the modules in the following conditions:

- a) Operating temperature: within -40°C (-40°F) to 85°C (185°F)
- b) Humidity: $< 85\text{RH}\%$

* Note: The mechanical load bearing (include wind and snow loads) of the module is based on the approved mounting methods. The professional system installer must be responsible for mechanical load calculation according to the system design.

2.2.2 Site selection

In most applications, Jinko solar PV modules should be installed in a location where they will receive maximum sunlight throughout the year. In the Northern Hemisphere, the module should typically face south, and in the Southern Hemisphere, the modules should typically face north. Modules facing 30 degrees away from true South (or North) will lose approximately 10 to 15 percent of their power output. If the module faces 60 degrees away from true South (or North), the power loss will be 20 to 30 percent.

When choosing a site, avoid trees, buildings or obstructions, which could cast shadows on the solar photovoltaic modules especially during the winter months when the arc of the sun is lowest over the horizon. Shading causes loss of output, even though the factory fitted bypass diodes of the PV module will minimize any such loss.

Do not install the PV module near open flame or flammable materials.

When solar modules are used to charge batteries, the battery must be installed in a manner, which will protect the performance of the system and the safety of its users. Follow the battery manufacturer's guidelines concerning installation, operation and maintenance recommendations. In general, the battery (or battery bank) should be away from the main flow of people and animal traffic. Select a battery site that is protected from sunlight, rain, snow, debris, and is well ventilated. Most batteries generate hydrogen gas when charging, which can be explosive. Do not light matches or create sparks near the battery bank. When a battery is installed outdoors, it should be placed in an insulated and ventilated battery case specifically

designed for the purpose.

Do not install the PV module in a location where it would be immersed in water or continually exposed to water from a sprinkler or fountain etc.

2.2.3 Tilt angle selection

The tilt angle of the PV module is measured between the surface of the PV module and a horizontal ground surface (Figure 1). The PV module generates maximum output power when it faces the sun directly.

For standalone systems with batteries where the PV modules are attached to a permanent structure, the tilt angle of the PV modules should be selected to optimize the performance based on seasonal load and sunlight. In general, if the PV output is adequate when irradiance is low (e.g., winter), then the angle chosen should be adequate during the rest of the year. For grid-connected installations where the PV modules are attached to a permanent structure, PV modules should be tilted so that the energy production from the PV modules will be maximized on an annual basis.

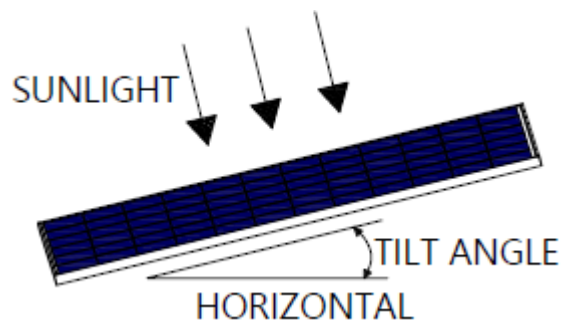

Figure1: PV module tilt angle

2.3 Mechanical Installation introduction

Solar PV modules usually can be mounted by using the following methods: bolts and clamps.

*** Note:**

- 1) All installation methods herein are only for reference, and Jinko solar will not provide related mounting components, the system installer or trained professional personnel must be responsible for the PV system's design, installation, and mechanical load calculation and security of the system.
- 2) Before installation, the following items should be addressed:
 - a) Visually check the module for any damage. Clean the module if any dirt or residue remains from shipping .
 - b) Check if module serial number stickers match.
- 3) Jinko modules are designed to meet a maximum positive (or downward) pressure of 5400Pa(Only refer to the mentioned module type in this manual) and negative (or upward)pressure of 2400Pa. When mounting modules in snow-prone or high-wind environments, special care should be taken to mount the modules in a manner that provides sufficient design strength while meeting local code requirements.

2.3.1 Fixation with bolts

For mounting with bolts, the following modules in tables 1 are applicable.

The frame of each module has 8 mounting holes (Length* Width: 14mm*9mm) used to secure the modules to support structure. Always use all the eight mounting holes to secure the modules. The module frame must be attached to a mounting rail using M8 corrosion-proof bolts together with spring washers and flat washers in eight symmetrical locations on the PV module. The applied torque value should be big enough to fix the modules steadily. The reference value for M8 bolt is 16~20N*m. As to special support system or special installation requirement, please reconfirm with the support's supplier for the torque value. Please find detailed mounting information in the below illustration as Figure 2.

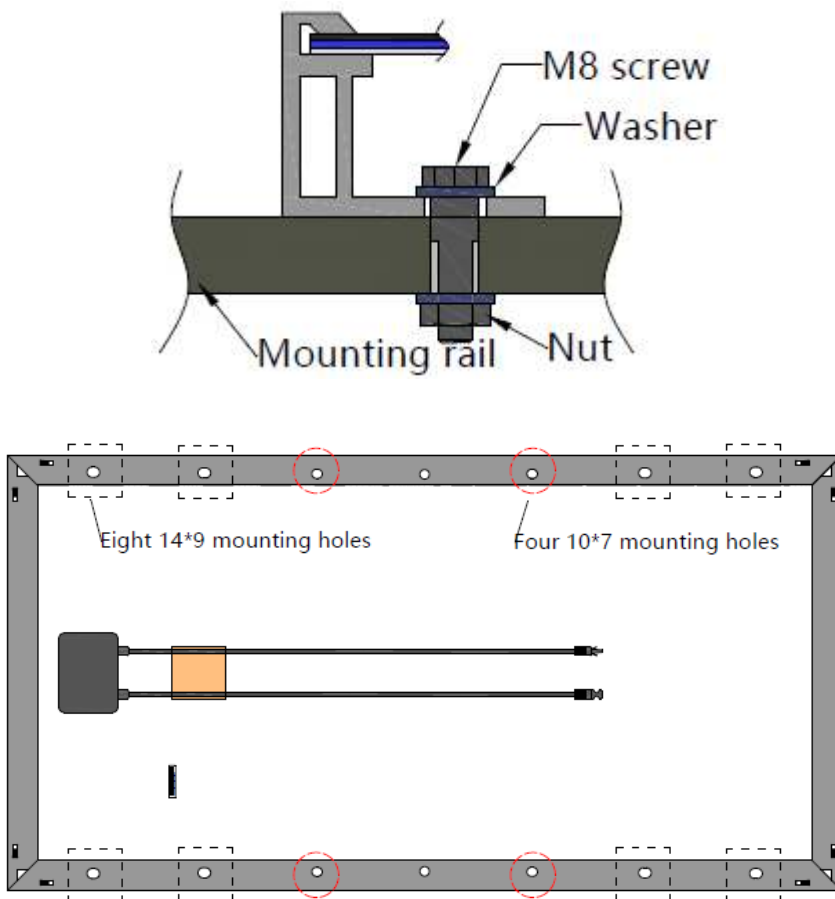

Figure 2: PV module installed with bolt fitting method

Module type	Dimensions(mm)	
	A*B	5400Pa
Group 1	1650*992	
	1650*990	
Group 2	1665*992	
Group 3	1650*992	
	1665*1002	
Group 4	1665*992	
	1684*1002	
Group 5	1956*992	
Group 6	1987*992	
Group 7	1956*992	
	1979*1002	
Group 8	1987*992	
	2008*1002	
Group 9	1324*992	
Group 10	1324*992	
Group 11	1704*1008	
Group 12	2031*1008	

Table 1: Mechanical dimensions for bolt fitting method

Notes: Group 1~10 refer to appendix for details.

2.3.2 Fixation with clamps

The module clamps should not come into contact with the front glass and must not deform the frame. Be sure to avoid shadowing effects from the module clamps. The module frame is not to be modified under any circumstances. When choosing this type of clamp-mounting method, please be sure to use at least four clamps on each module, two clamps should be attached on each long sides of the module. Depending on the local wind and snow loads, if excessive pressure load is expected, additional clamps or support would be required to ensure the module can bear the load. The applied torque value should be big enough to fix the modules steadily (Please consult with the clamp or support's supplier for the specific torque value). Please find detailed mounting information in the below illustration, the mounting place distance is suggested bigger than J and less than K. The installation diagram of clamp is shown in figure 3. Note: The Movement of the mounting rail and the clamps center line are recommended to be within the black arrow area.

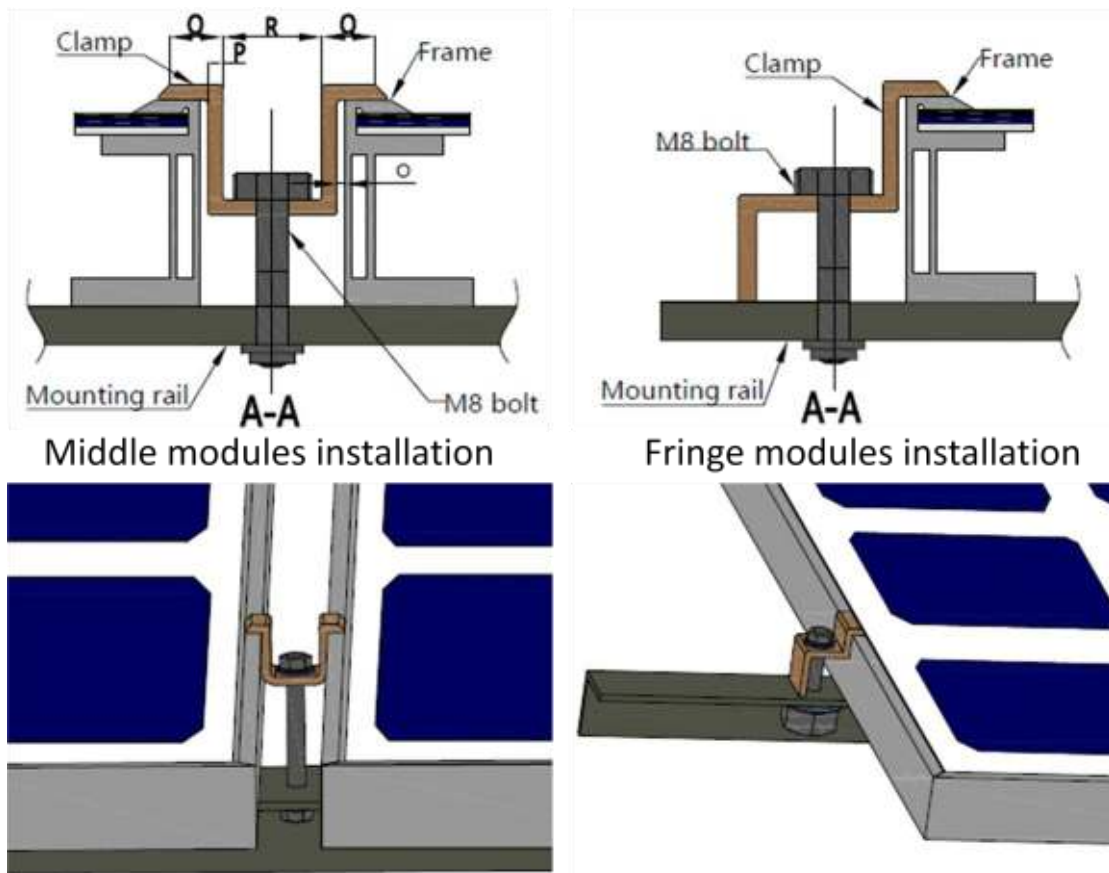

Figure 3: PV module installed at the side with Clamp fitting method

When installing modules using clamps on the long side of the frame, the applicable product types and installation locations are shown in figure 4 and table 2.

When installing modules using clamps on the short side of the frame, the applicable product types and installation locations are shown in figure 5 and table 3.

When installing modules using clamps on the long side & short side of the frame, the applicable product types and installation locations are shown in figure 6 and table 4.

When installing modules using clamps & screws on the long side & short side of the frame, The considerations and requirements for mounting with clamps and or screws, please refer to the instructions in 2.3.2. The mounting place distance on short side is suggested bigger than J and less than K, the applicable product types and installation locations are shown in figure 7 and table 5.

2.3.2.1 Fixation with clamps at long sides of frames

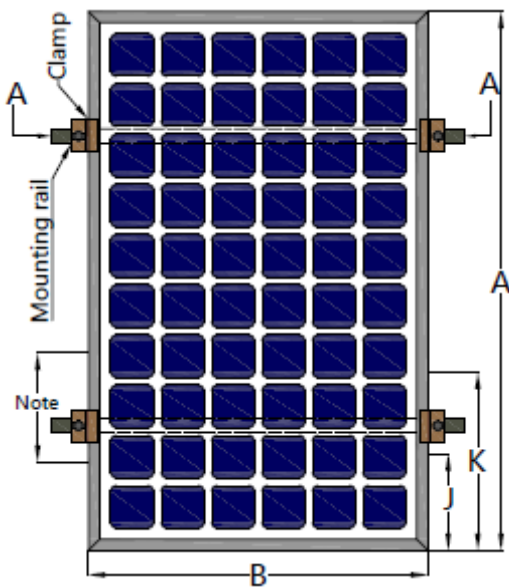

Module type	Dimensions(mm)				
	A*B	5400Pa		2400Pa	
		J	K	J	K
Group 1	1650*992	280	420	0	480
Group 2	1665*992	280	420	0	480
Group 3	1650*992	280	420	0	480
	1665*1002				
Group 4	1665*992	280	420	0	480
	1684*1002				
Group 5	1956*992	280	480	0	480
Group 6	1987*992	280	480	0	480
Group 7	1956*992	280	480	0	480
	1979*1002				
Group 8	1987*992	280	480	0	480
	2008*1002				
Group 9	1324*992	240	270	—	—
Group 10	1324*992	240	270	—	—
Group 11	1704*1008	280	420	—	—
Group 12	2031*1008	280	480	—	—

Figure 4: Installation methods of clamps on long sides

Table 2: Mechanical dimensions when modules installed at long side with Clamp fitting method (Note: The installation method of 2400Pa is based on the experimental results in jinko.)

2.3.2.2 Fixation with clamps at short sides of the frames

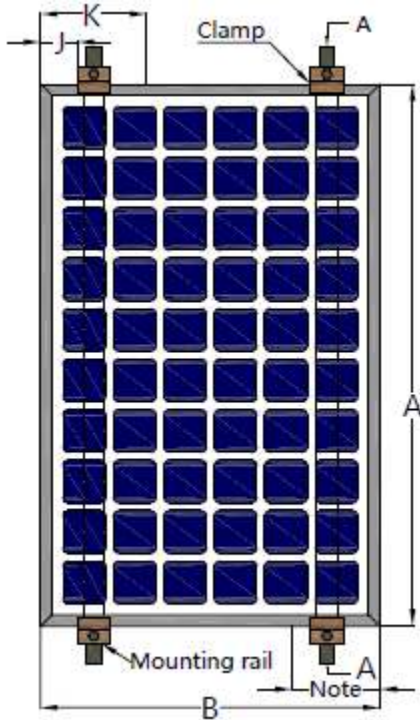

Module type	Dimensions(mm)		
	A*B	2400Pa	
		J	K
Group 1	1650*992	50	240
	1650*990		
Group 3	1650*992	50	240
	1665*1002		
Group 5	1956*992	50	240
Group 7	1956*992	50	240
	1979*1002		
Group 9	1324*992	50	240
Group 10	1324*992	50	240

Table 3: Mechanical dimensions when modules installed at short side with Clamp fitting method

Figure 5: Installation methods of clamps on short sides

2.3.2.3 Fixation with clamps at the long & short sides

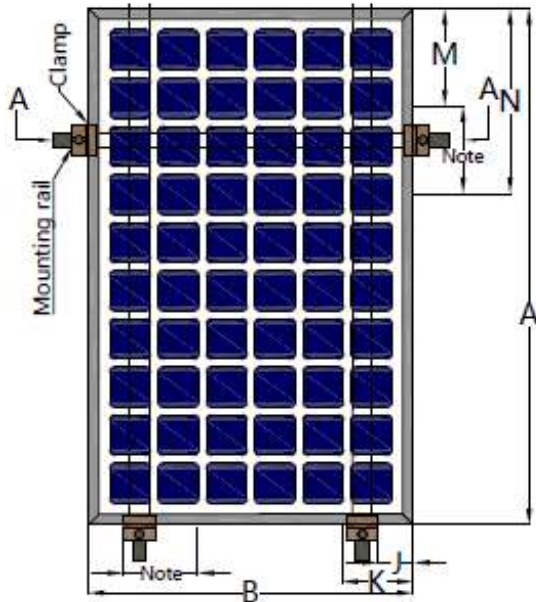

Module type	Dimensions(mm)				
	A*B	2400Pa			
		J	K	M	N
Group 1	1650*992	50	240	280	420
	1650*990				
Group 3	1650*992	50	240	280	420
	1665*1002				
Group 5	1956*992	50	240	280	480
Group 7	1956*992	50	240	280	480
	1979*1002				
Group 9	1324*992	50	240	240	270
Group 10	1324*992	50	240	240	270

Table 4: Mechanical dimensions when modules installed at long and short sides with Clamp fitting method

Figure 6: Installation methods of clamps on long and short sides

2.3.3 Fixation with screws & clamps at the long & short sides

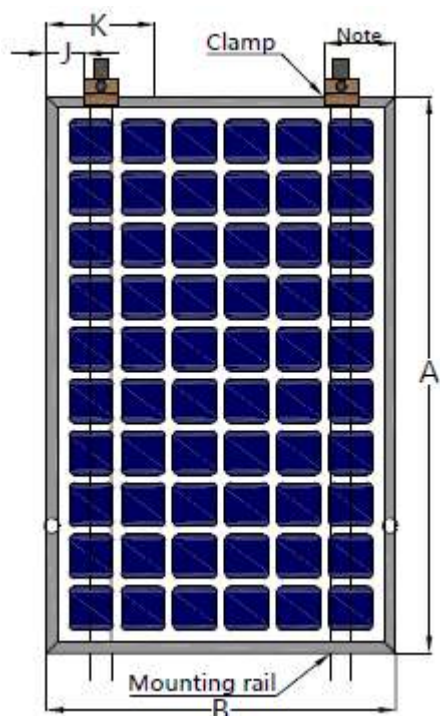

Module type	Dimensions(mm)		
	A*B	2400Pa	
		J	K
Group 1	1650*992 1650*990	50	240
Group 3	1650*992 1665*1002	50	240
Group 5	1956*992	50	240
Group 7	1956*992 1979*1002	50	240
Group 9	1324*992	50	240
Group 10	1324*992	50	240

Table 5: Mechanical dimensions when modules installed at long and short sides with Screws and Clamps fitting method

Figure 7: Installation methods of screws & clamps on long and short sides

3. Wiring and connection

- Before this procedure, please read the operation instructions of the PV system carefully. Make wiring by Multi-connecting cables between the PV modules in series or parallel connection, which is determined by user's configuration requirement for system power, current and voltage.
- PV modules connected in series should have similar current, and modules must not be connected together to create a voltage higher than the permitted system voltage. The maximum number of modules in series depends on system design, the type of inverter used and environmental conditions.
- The maximum fuse rating value in an array string can be found on the product label or in the product datasheet. The fuse rating value is also corresponding to the maximum reverse current that a module can withstand, i.e. when one string is in shade then the other parallel strings of modules will be loaded by the shaded string and the current will pass through to create a current circuit. Based on the maximum series fuse rating of module and local electrical codes and standards, make sure the modules strings in parallel are protected with the appropriate in-line string fusing.

- d) Open the combiner box of the control system and connect the conductor from the PV arrays to the combiner box in accordance with the design and local codes and standards. The cross-sectional area and cable connector capacity must satisfy the maximum short-circuit of the PV system (for a single component, we recommended that the cross-sectional area of cables be 4mm^2 and the rated current of connectors be more than 10A), otherwise cables and connectors will become overheating for large current. Please pay attention to the temperature limit of cables is 85°C .
- e) All module frames and mounting racks must be properly grounded in accordance with local and national electrical codes. Attach the equipment grounding conductor to the module frame using the hole and hardware provided. Note that a stainless steel star washer is used between the ground wire and module frame (see Figure 8 below). This washer is used to avoid corrosion due to dissimilar metals. Tighten the screw securely.

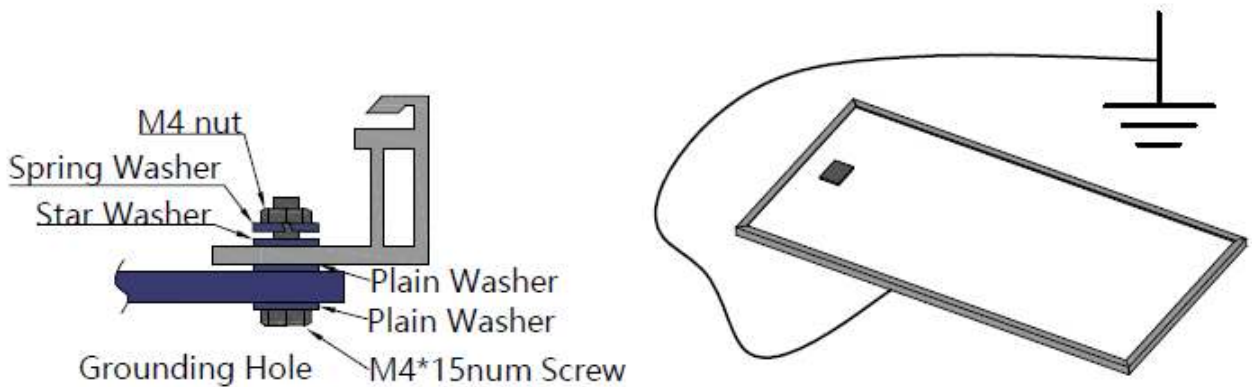

Figure 8: The graph of Grounding

- f) Follow the requirements of applicable local and national electrical codes.
- g) These modules contain factory installed bypass diode .If these modules are incorrectly connected to each other, the bypass diodes, cable or junction box may be damaged.
- h) The cable of the junction box is defined as L, as showed below in Figure 9. For Jinko standard module, L is 900/1200mm; and for customized module, L can be based on your condition. Please take the cable length into consideration before designing the wiring layout.

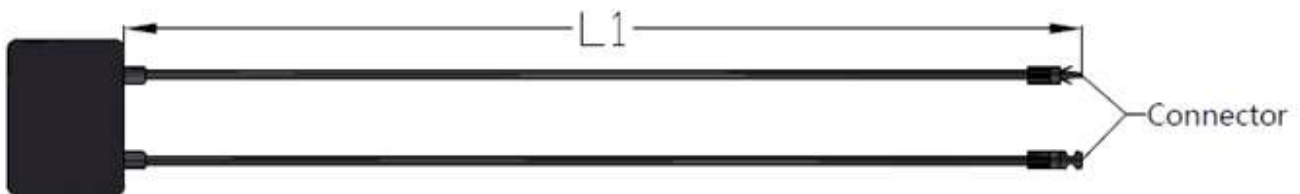

Figure 9: Junction box

- i) It is recommend to use negatively grounded inverters to avoid the PID effect for non-PID free modules.

4. Maintenance and care

It is required to perform regular inspection and maintenance of the modules, especially during the warranty period. To ensure optimum module performance, Jinko recommends the following maintenance measures:

4.1 Visual Inspection

Inspect the modules visually to find if there are any visual defects, If there are, the following items should be evaluated:

- a) If modules are observed having slight cell color differences at different angles, this is a normal phenomenon of modules with anti-reflection coating technology.
- b) Whether the glass is broken.
- c) No sharp objects are in contact with the PV module surfaces.
- d) PV modules are not shaded by unwanted obstacles and; or foreign material.
- e) Corrosion along the cells' bus-bar. The corrosion is caused by moisture intrusion through the module back sheet. Check the back sheet for damage.
- f) Check whether the back sheet is burn out.
- g) Check if screws and mounting brackets are tight, adjust and tighten as necessary.

4.2 Cleaning

- a) A build up of dust or dirt on the module(s) front face will result in a decreased energy output. Clean the panel(s) preferably once per annum if possible (depend on site conditions) using a soft cloth dry or damp, as necessary. Water with high mineral content may leave deposits on the glass surface and is not recommended.
- b) Never use abrasive material under any circumstances.
- c) In order to reduce the potential for electrical and thermal shock, Jinko recommends cleaning PV modules during early morning or late afternoon hours when solar radiation is low and the modules are cooler, especially in regions with hotter temperatures.
- d) Never attempt to clean a PV module with broken glass or other signs of exposed wiring, as this presents a shock hazard.
- e) Never use chemicals when cleaning modules as this may affect the module warranty and energy output.

4.3 Inspection of Connector and Cable

It's recommended to implement the following preventive maintenance every 6 months:

- a) Check the sealing gels of the junction box for any damage.
- b) Examine the PV module(s) for signs of deterioration. Check all wiring for possible rodent damage, weathering and that all connections are tight and corrosion free. Check electrical leakage to ground.

5. Electrical specification

The module electrical rating are measured under Standard Test Conditions, which are 1000W/m², irradiance with AM 1.5 spectrum and 25 deg (77°F) ambient temperature. The module might produce more or less voltage or current than rated value in uncertainty condition. The corresponding electrical specifications can be downloaded from website. www.jinkosolar.com.

6. Disclaimer of Liability

Because the use of the manual and the conditions or methods of installation, operation, use and maintenance of photovoltaic (PV) product are beyond Jinko's control, Jinko does not accept responsibility and expressly disclaims liability for loss, damage, or expense arising out of or in any way connected with such installation, operation, use or maintenance.

No responsibility is assumed by Jinko for any infringement of patents or other rights of third parties, which may result from use of the PV product. NO license is granted by implication or otherwise under any patent or patent rights.

The information in this manual is based on Jinko's knowledge and experience and is believed to be reliable, but such information including product specification (without limitations) and suggestions do not constitute a warranty, expresses or implied. Jinko reserve the right to change the manual, the PV produce, the specifications, or product information sheets without prior notice.

Appendix : Applicable Products

This document is applicable to the series of solar modules as listed below:

With 6" poly and mono c-Si:

Group 1

JKMxxxP-60	JKMxxxP-60-J	JKMxxxPP ^① -60	JKMxxxPP-60-J
JKMxxxP-60-J4 ^②	JKMxxxPP-60-J4	JKMxxxP-60(Plus) ^③	JKMxxxPP-60(Plus)
JKMxxxPP-60(Plus)-J	JKMxxxP-60-J4-J	JKMxxxPP-60-J4-J	JKMxxxPP-60-J4(Plus)
JKMS ^④ xxxP-60	JKMSxxxP-60-J	JKMSxxxP-60-J4	JKMSxxxP-60(Plus)
JKMSxxxPP-60	JKMSxxxPP-60-J	JKMSxxxPP-60-J4	JKMSxxxPP-60-W ^⑤ -MX
JKMSxxxPP-60(Plus)-J	JKMSxxxP-60-J4-J	JKMSxxxPP-60-J4-J	JKMSxxxPP-60(Plus)
JKMSxxxPP-60-MX ^⑥	JKMSxxxPP-60B ^⑦ -MX	JKMSxxxPP-60-J4-MX	JKMSxxxPP-60B-J4-MX
JKMSxxxPP-60(Plus)-MX			
JKMxxxPP-60-MW ^⑧	JKMxxxPP-60-J-MW	JKMxxxPP-60(Plus)-MW	JKMxxxPP-60(Plus)-J-MW
JKMxxxPP-60B-MW	JKMSxxxPP-60-MX-MW	JKMSxxxPP-60B-MX-MW	JKMSxxxPP-60(Plus)-MX-MW
JKMxxxP-60-V ^⑨	JKMxxxP-60-V-J	JKMxxxPP-60-V	JKMxxxPP-60-V-J
JKMxxxPP-60-J4V	JKMSxxxP-60-V	JKMSxxxP-60-V-J	JKMSxxxPP-60-V
JKMSxxxPP-60-V-J	JKMSxxxPP-60-MX-V	JKMSxxxPP-60B-MX-V	JKMSxxxPP-60-J4-MX-V
JKMSxxxPP-60B-J4-MX-V	JKMSxxxPP-60(Plus)-MX-V	JKMSxxxPP-60-W-MX-V	JKMSxxxM-60-MX-MW-V
JKMSxxxPP-60-MX-MW-V	JKMSxxxPP-60B-MX-MW-V	JKMxxxPP-60-MW-V	JKMxxxPP-60-J-MW-V

(xxx=210~325,in increment of 5)

Group 2

JKMxxxPP-60H	JKMxxxPP-60H-J4	JKMxxxPP-60H-MW	
JKMxxxPP-60H ^⑩ B-V	JKMxxxPP-60H-J4-V	JKMxxxPP-60H-V	JKMxxxPP-60H-MW-V
JKMxxxPP-60HB	JKMxxxPP-60HB-MW		

(xxx =210~325,in increment of 5)

Group 3

JKMxxxM-60	JKMxxxM-60-J	JKMxxxM-60(Plus)	JKMSxxxM-60
JKMSxxxM-60-J	JKMSxxxM-60(Plus)	JKMxxxM-60B	JKMSxxxM-60B
JKMSxxxM-60-MX	JKMSxxxM-60B-MX	JKMSxxxM-60(Plus)-MX	JKMxxxM-60B-FS ^⑪
JKMxxxM-60-MW	JKMxxxM-60-J-MW	JKMxxxM-60(Plus)-MW	JKMxxxM-60B-MW
JKMSxxxM-60-MX-MW	JKMSxxxM-60B-MX-MW	JKMSxxxM-60(Plus)-MX-MW	JKMxxxM-60-J-MW-V
JKMxxxM-60-V	JKMxxxM-60-V-J	JKMSxxxM-60-V	JKMSxxxM-60-V-J
JKMSxxxM-60-MX-V	JKMSxxxM-60B-MX-V	JKMSxxxM-60(Plus)-MX-V	JKMxxxM-60-MW-V
JKMxxxM-60L ^⑫	JKMxxxM-60BL	JKMxxxM-60L-V	JKMxxxM-60BL-V

(xxx =210~350,in increment of 5)

Group 4

JKMxxxM-60H	JKMxxxM-60HB	JKMxxxM-60H-FS	JKMxxxM-60HB-FS
JKMxxxM-60H-MW	JKMxxxM-60HB-MW		
JKMxxxM-60H-V	JKMxxxM-60HB-V	JKMxxxM-60H-MW-V	

JKMxxxM-60HL	JKMxxxM-60HBL	JKMxxxM-60HL-V	JKMxxxM-60HBL-V
--------------	---------------	----------------	-----------------

(xxx =210~350,in increment of 5)

Group 5

JKMxxxP-72	JKMxxxP-72-J	JKMxxxPP-72	JKMxxxPP-72-J
JKMxxxP-72-J4	JKMxxxPP-72-J4	JKMxxxP-72(Plus)	JKMxxxPP-72(Plus)
JKMxxxPP-72(Plus)-J	JKMxxxP-72-J4-J	JKMxxxPP-72-J4-J	JKMxxxPP-72-J4(Plus)
JKMSxxxP-72	JKMSxxxP-72-J	JKMSxxxP-72-J4	JKMSxxxP-72(Plus)
JKMSxxxPP-72	JKMSxxxPP-72-J	JKMSxxxPP-72-J4	JKMSxxxPP-72(Plus)
JKMSxxxPP-72(Plus)-J	JKMSxxxP-72-J4-J	JKMSxxxPP-72-J4-J	
JKMSxxxPP-72-MX	JKMSxxxPP-72B-MX	JKMSxxxPP-72-J4-MX	
JKMSxxxPP-72B-J4-MX	JKMSxxxPP-72(Plus)-MX	JKMSxxxPP-72-W-MX	JKMSxxxPP-72(Plus)-MX-MW
JKMxxxPP-72-MW	JKMxxxPP-72-J-MW	JKMxxxPP-72(Plus)-MW	JKMxxxPP-72(Plus)-J-MW
JKMxxxPP-72B-MW	JKMSxxxPP-72-MX-MW	JKMSxxxPP-72B-MX-MW	
JKMxxxP-72-V	JKMxxxP-72-V-J	JKMxxxPP-72-V	JKMxxxPP-72-V-J
JKMxxxPP-72-J4V	JKMSxxxP-72-V	JKMSxxxP-72-V-J	JKMSxxxPP-72-V
JKMSxxxPP-72-V-J	JKMSxxxPP-72-MX-V	JKMSxxxPP-72B-MX-V	JKMSxxxPP-72-J4-MX-V
JKMSxxxPP-72B-J4-MX-V	JKMSxxxPP-72(Plus)-MX-V	JKMSxxxPP-72-W-MX-V	JKMxxxPP-72-MW-V
JKMxxxPP-72-J-MW-V	JKMS320M-72-MX-MW-V	JKMSxxxPP-72-MX-MW-V	JKMSxxxPP-72B-MX-MW-V

(xxx =250~390,in increment of 5)

Group 6

JKMxxxPP-72H	JKMxxxPP-72H-J4	JKMxxxPP-72HB	JKMxxxPP-72H-MW
JKMxxxPP-72HB-MW			
JKMxxxPP-72HB-V	JKMxxxPP-72H-J4V	JKMxxxPP-72H-V	JKMxxxPP-72H-MW-V

(xxx =250~390,in increment of 5)

Group 7

JKMxxxM-72	JKMxxxM-72-J	JKMxxxM-72(Plus)	JKMSxxxM-72
JKMSxxxM-72-J	JKMSxxxM-72(Plus)	JKMxxxM-72B	JKMSxxxM-72B
JKMSxxxM-72-MX	JKMSxxxM-72B-MX	JKMSxxxM-72(Plus)-MX	JKMxxxM-72B-FS
JKMxxxM-72-MW	JKMxxxM-72-J-MW	JKMxxxM-72(Plus)-MW	JKMxxxM-72B-MW
JKMSxxxM-72-MX-MW	JKMSxxxM-72B-MX-MW	JKMSxxxM-72(Plus)-MX-MW	JKMxxxM-72-V
JKMxxxM-72-V-J	JKMSxxxM-72-V	JKMSxxxM-72-V-J	JKMSxxxM-72-MX-V
JKMSxxxM-72B-MX-V	JKMSxxxM-72(Plus)-MX-V	JKMxxxM-72-MW-V	JKMxxxM-72-J-MW-V
JKMxxxM-72L	JKMxxxM-72L-V		

(xxx =250~420,in increment of 5)

Group 8

JKMxxxM-72H	JKMxxxM-72HB	JKMxxxM-72H-MW	JKMxxxM-72H-MW
JKMxxxM-72H-FS	JKMxxxM-72HB-FS	JKMxxxM-72HB-FS	
JKMxxxM-72H-V	JKMxxxM-72HB-V	JKMxxxM-72H-MW-V	
JKMxxxM-72HL	JKMxxxM-72HL-V		

(xxx =250~420,in increment of 5)

Group 9

JKMxxxP-48	JKMxxxP-48-J	JKMxxxP-48-J4	JKMxxxPP-48
JKMxxxPP-48-J	JKMxxxPP-48-J4	JKMxxxPP-48(Plus)	JKMxxxPP-48(Plus)-J
JKMxxxP-48-J4-J	JKMxxxPP-48-J4-J	JKMxxxPP-48-J4(Plus)	JKMSxxxP-48(Plus)
JKMSxxxP-48	JKMSxxxP-48-J	JKMSxxxP-48-J4	JKMSxxxPP-48(Plus)
JKMSxxxPP-48	JKMSxxxPP-48-J	JKMSxxxPP-48-J4	JKMSxxxPP-48(Plus)-J
JKMSxxxP-48-J4-J	JKMSxxxPP-48-J4-J	JKMSxxxPP-48(Plus)-MX	JKMSxxxPP-48-W-MX
JKMSxxxPP-48-MX	JKMSxxxPP-48B-MX	JKMSxxxPP-48-J4-MX	JKMSxxxPP-48B-J4-MX
JKMxxxPP-48-MW	JKMxxxPP-48-J-MW	JKMxxxPP-48(Plus)-MW	JKMxxxPP-48(Plus)-J-MW
JKMxxxPP-48B-MW	JKMSxxxPP-48-MX-MW	JKMSxxxPP-48B-MX-MW	JKMSxxxPP-48(Plus)-MX-MW
JKMxxxP-48-V	JKMxxxP-48-V-J	JKMxxxPP-48-V	JKMxxxPP-48-V-J
JKMxxxPP-48-J4V	JKMSxxxP-48-V	JKMSxxxP-48-V-J	JKMSxxxPP-48-V
JKMSxxxPP-48-V-J	JKMSxxxPP-48-MX-V	JKMSxxxPP-48B-MX-V	JKMSxxxPP-48-J4-MX-V
JKMSxxxPP-48B-J4-MX-V	JKMSxxxPP-48(Plus)-MX-V	JKMSxxxPP-48-W-MX-V	JKMxxxPP-48-MW-V
JKMxxxPP-48-J-MW-V			

(xxx =170~230,in increment of 5)

Group 10

JKMxxxM-48	JKMxxxM-48-J	JKMSxxxM-48	JKMSxxxM-48-J
JKMSxxxM-48(Plus)	JKMSxxxM-48-MX	JKMSxxxM-48B-MX	JKMSxxxM-48(Plus)-MX
JKMxxxM-48-MW	JKMxxxM-48-J-MW	JKMxxxM-48B-MW	
JKMSxxxM-48-MX-MW	JKMSxxxM-48B-MX-MW	JKMSxxxM-48(Plus)-MX-MW	
JKMxxxM-48-V	JKMxxxM-48-V-J	JKMSxxxM-48-V	JKMSxxxM-48-V-J
JKMSxxxM-48-MX-V	JKMSxxxM-48B-MX-V	JKMSxxxM-48(Plus)-MX-V	JKMxxxM-48-MW-V
JKMxxxM-48-J-MW-V			

(xxx =170~250,in increment of 5)

Group 11

JKMxxxM-60H-TV®			
-----------------	--	--	--

(xxx =300~340,in increment of 5)

JKMxxxN-60H-TV			
----------------	--	--	--

(xxx =315~355,in increment of 5)

Group 12

JKMxxxM-72H-TV	JKMxxxN-72H-TV		
----------------	----------------	--	--

(xxx =375~415,in increment of 5)

Notes:

- ◆ PP: the eagle Series module
- ◆ J4: the eagle black Series module
- ◆ Plus: the eagle+ Series module
- ◆ JKMS: the smart module
- ◆ W:the light PV module
- ◆ MX: module with PV-07Bxy junction box
- ◆ B: module with black back sheet

- ◆ MW:12 BB Series module
- ◆ V:Module with 1500V
- ◆ H:Half-cut Series module
- ◆ FS: Full Size Series module
- ◆ L: large cell series module
- ◆ TV:SWAN bifacial module

Note

Global Sales & Marketing Center

Jinko Building
#99 Shouyang Road, Jingan District,
Shanghai, China 200027
Tel: +86 21 5183 8777
Fax: +86 21 5180 8600

Jiangxi Manufacture Base

No.1 Jinko Road,
Shangrao Economic Development Zone,
Jiangxi Province, China 334100
Tel:+86 793 858 8188
Fax:+86 793 846 1152

Zhejiang Manufacture Base

No.58 Yuanxi Road,
Haining Yuanhua Industrial Park,
Zhejiang Province, China 314416
Tel: +86 573 8798 5678
Fax: +86 573 8787 1070