

ShineLink-X2 User Manual

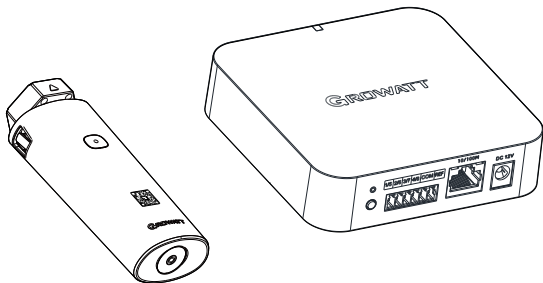

Disclaimer: The content of this document is continually reviewed and amended, where necessary. Growatt reserves the right to make changes to the material at any time and without notice.

Copyright © 2025 Shenzhen Growatt New Energy Co., Ltd. All rights reserved.

1. Product Overview

ShineLink-X2 is a wireless monitoring product composed of a master and slave datalogger, which connect to PV devices such as the PV inverter and the hybrid inverter via RF wireless, and enable remote monitoring and maintenance of PV systems through router or 4G network.

- Supports mobile App and Server web page monitoring
- Supports remote configuration and firmware upgrade
- Supports local data saving and break point retransmission
- Supports WiFi, LAN, 4G (optional) network to configure the network of the datalogger

2. Product Appearance

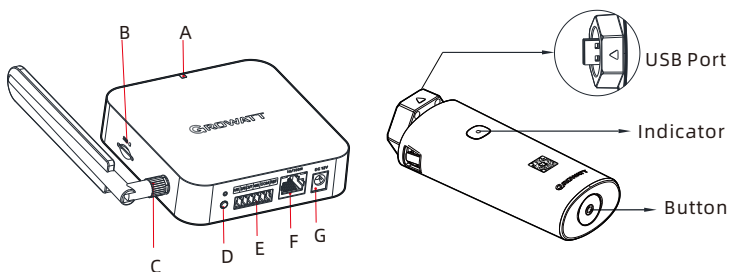

No.	Identification
A	Indicator light
B	SIM card slot (Only the 4G version will have)
C	4G antenna terminal (Only the 4G version will have)
D	Button
E	DRM Port
F	RJ45 Port
G	Power input Port

3. System Diagram

3.1 Wireless RF System Diagram

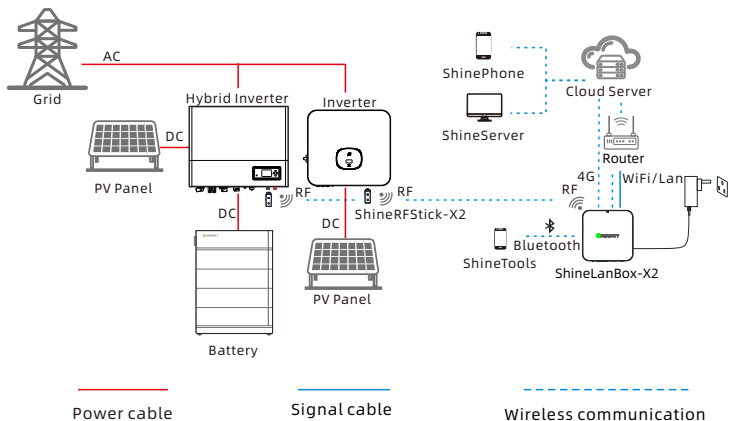

3.2 Micro inverter RF system diagram

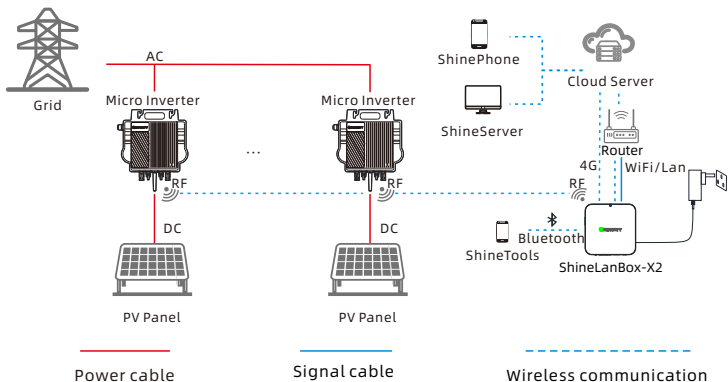

4. Installation and Configuration

4.1 Installation Instructions

4.1.1 ShineLanBox-X2 Installation

1. Place ShineLanBox-X2 on the desktop

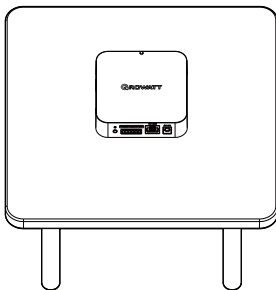

2. Wall mount the ShineLanBox-X2

Step 01: Mark two wall mounting points with 50mm spacing on the surface

Step 02: Drill an 8mm diameter, 25mm deep hole and install a plastic column along with a screw

Step 03: Mount the ShineLanBox-X2 onto the wall

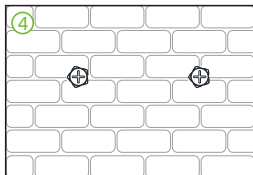
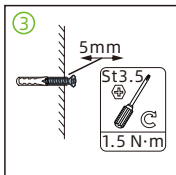
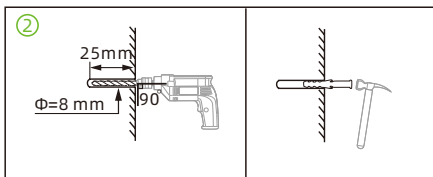
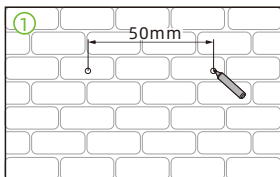

3. 4G Antenna Installation and SIM Card Insertion (Only the 4G version needs attention)

Insert the SIM card into the designated slot, and secure the 4G antenna by tightening clockwise.

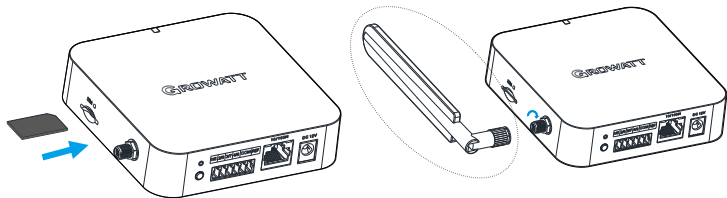

4.1.2 ShineRFStick-X2 Installation

1. Rotate and twist the USB interface cover of the photovoltaic device counterclockwise.
2. Rotate the lock at the top of the datalogger to ensure that the triangle mark is on the front and centered.
3. Connect the interface of the datalogger to the USB interface of the photovoltaic device, ensure that the triangle mark is on the front, press the lock and rotate clockwise until the lock is tightened.

Ensure that the triangle icon is facing upward and centered, then turn the lock clockwise

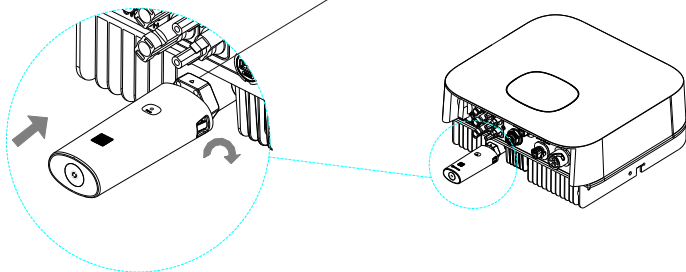

4.2 Turning on the device and Checking the Connection Status

- When the ShineLanBox-X2 is initially powered on, the white light will remain on for 30 seconds.
- After installing the ShineRFStick-X2 , power on the PV device. When it is successfully connected to the PV device and ShineLanBox-X2 , it slowly flashes blue light.



Warning

- This product can only be powered by the USB port of Growatt inverters. Do not connect it to other USB ports or adapters.
- If the inverter displays a low insulation resistance alarm, it indicates that a ground fault might have occurred in the chassis. Do not connect the datalogger to the inverter or perform other operations to avoid personal injury.
- Do not use this product in places where the use of wireless devices is not allowed.
- Do not try to repair or modify the equipment by yourself. If you need any support, please contact us.

4.3 Datalogger Configuration

1. Scan the QR code below to download ShinePhone, or you can search for ShinePhone in Apple Store or Google Play, then download and install the latest version of the App.
2. Once the App is installed, you can configure the ShineLink-X2. For details about configuring the datalogger, please refer to ShineLink-X2 Configuration Guide, which can be obtained by scanning the QR code below.



【ShinePhone APP】



【ShineLink-X2
Configuration Guide】

4.4 Button Description

Operation	Description
Click the button(the indicator light will turn steady yellow)	ShineLanBox-X2/ShineRFStick-X2 enter Bluetooth mode.If you not need this mode,click the button to exit.
Double click the button(the indicator light will flash yellow)	ShineLanBox-X2/ShineRFStick-X2 enter the RF pairing mode.If no pairing is required, double- click the button to exit pairing mode.
Click and hold the button for 6s until the indicator light turns white	Restore the ShineLanBox-X2/ ShineRFStick-X2 to factory default settings.

4.5 Troubleshooting

➤ 1. ShineRFStick-X2 Troubleshooting

LED status	Operating status	Troubleshooting
Steady White	Initialized or in the state of restoring factory default settings	Wait for 30S initialization to complete.
Steady Blue	the ShineLanBox-X2 is not connected	Please connect the ShineLanBox-X2 according to the pairing process
Blue Flashing Slowly	Connected to ShineLanBox-X2,and the PV device	Operating normally

For detailed troubleshooting of indicator light faults, please refer to the ShineLink-X2 Configuration Guide.

➤ 2. ShineLanBox-X2 Troubleshooting

LED status	Operating status	Troubleshooting
Steady White	Initialized or in the state of restoring factory default settings	Wait for initialization to complete
Steady Yellow	In Bluetooth mode	Please continue to follow the APP instructions for networking/sub-device addition process. If not needed, please click the button to exit the mode.
Steady Green	Failed to connect to the ShineRFStick-X2	Please continue with the sub-device addition process according to the APP Instructions.
Blue Flashing Slowly	Communicate with router/4G network, server and ShineRFStick-X2 normally.	Operating normally
For detailed troubleshooting of indicator light faults, please refer to the ShineLink-X2 Configuration Guide.		

5. Specification

5.1 ShineLanBox-X2 Product specifications

Type	Item	Parameter
Common parameters	Appearance (length/width/height)	100*100*27mm
	Weight	Standard version:126g 4G version:150g
	Protection level	IP20
	Installation	Desktop, Wall Mount
	Certification	CE/ROHS
Electrical parameters	Operating voltage	12V(+/-5%)
	Typical power consumption	Standard version:3W 4G version:5W
	Working temperature	-30~60°C
	Working humidity	<85%RH(No condensation)
	Storage temperature	-40~70°C
Communication parameters	RF	1. Frequency range: 860~ 930MHz (868/915MHz RF) 2. Maximum transmit power: 868MHz 14dBm/915MHz 17dBm 3. Maximum transmission distance:120m (depending on the installation environment) 4. Facility Management Number: Monitoring Number-12Pcs
	BLE	1. Compliant with Bluetooth V4.2(2.4GHz) 2. Transmission distance: open 10m

Type	Item	Parameter
Communication parameters	WiFi	<ol style="list-style-type: none"> 1. Frequency range: 2412~2484 MHz(2.4 GHz WiFi) 2. Support 802.11 b/g/n protocol, with a maximum speed of 150Mbps. 3. Maximum output power 19.5dBm, receiving sensitivity up to -97dBm 4. Transmission distance: 50m (depending on the installation environment)
	LAN	<ol style="list-style-type: none"> 1. 10/100M Self-Adaptation 2. Communication distance:100m (Cat5e-SFTP or above)
	4G	<ol style="list-style-type: none"> 1. Standard & frequency band: LTE-TDD B38/B40/B41 LTE-FDD B1/B3/B5/B7/B8/ B20 2. Data rate: Uplink (50Mbps) Downlink (150Mbps)
Application parameters	Supported servers	ShineServer
	User configuration interface	APP configuration
	Data upload cycle	5Min
	Communication protocol with server	MQTT

5.2 ShineRFStick-X2 Product specifications

Type	Item	Parameter
Common parameters	Appearance (length/width/height)	122mm*47mm*32mm

Type	Item	Parameter
Common parameters	Weight	65g
	User manual language	English
	Protection level	IP65
	Installation	USB straight plug
	Certification	CE/ROHS
Electrical parameters	Working voltage	5V(+/-5%)
	Working current	500mA
	Typical power consumption	2.5W
	Elevation	≤3000m
	Working temperature	-30~60°C
	Working humidity	<85%RH(No condensation)
	Storage temperature	-40~70°C
Application parameters	RF	<ol style="list-style-type: none"> 1. Frequency range: 860~ 930MHz (868/915MHz RF) 2. Maximum transmit power: 868MHz 14dBm/915MHz 17dBm 3. Maximum transmission distance: 120m (depending on the installation environment)
	User configuration interface	APP configuration
	Data upload cycle	5Min
	Communication protocol with photovoltaic equipment	ModBus RTU

6. Declaration of conformity

This product complies with the following regulations and requirements:

- Electromagnetic Compatibility Directive: 2014/30/EU (EMC)
- Radio Equipment Directive: 2014/53/EU (RED)
- Electrical Equipment (Safety) Regulations 2016: 2014/35/EU (LVD)
- Restriction of Hazardous Substances Directive: 2011/65/EU (EU) and 2015/863 (RoHS)

You can download the Declaration of Compliance at
<https://en.growatt.com>

7. Contact

Shenzhen Growatt New Energy Co., Ltd.

4-13/F, Building A, Sino-German (Europe) Industrial Park,
Hangcheng Blvd, Bao'an District, Shenzhen, China

✉ service@growatt.com

🌐 en.growatt.com

For local customer support, please visit
<https://en.growatt.com/support/contact>

GR-UM-506-A-00 (PN:044.0151800)



Download
Manual



Growatt New Energy